



# 10CTQ150SPbF 10CTQ150-1PbF

SCHOTTKY RECTIFIER

10 Amp

$$I_{F(AV)} = 10\text{Amp}$$

$$V_R = 150\text{V}$$

### Major Ratings and Characteristics

Characteristics	Values	Units
$I_{F(AV)}$ Rectangular waveform	10	A
$V_{RRM}$	150	V
$I_{FSM}$ @ tp = 5 $\mu$ s sine	620	A
$V_F$ @ 5 Apk, $T_J = 125^\circ\text{C}$ (per leg)	0.73	V
$T_J$ range	-55 to 175	$^\circ\text{C}$

### Description/ Features

This center tap Schottky ectifier has been optimized for low reverse leakage at high temperature. The proprietary barrier technology allows for reliable operation up to 175 $^\circ\text{C}$  junction temperature. Typical applications are in switching power supplies, converters, free-wheeling diodes, and reverse battery protection.

- 175 $^\circ\text{C}$   $T_J$  operation
- Center tap configuration
- Low forward voltage drop
- High purity, high temperature epoxy encapsulation for enhanced mechanical strength and moisture resistance
- High frequency operation
- Guard ring for enhanced ruggedness and long term reliability
- Lead-Free ("PbF" suffix)

### Case Styles

10CTQ150SPbF

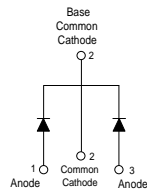

**D<sup>2</sup>PAK**

10CTQ150-1PbF

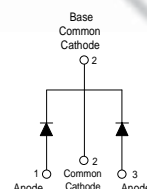

**TO-262**

## Voltage Ratings

Parameters	10CTQ150SPbF, 10CTQ150-1PbF
$V_R$ Max. DC Reverse Voltage (V)	150
$V_{RWM}$ Max. Working Peak Reverse Voltage (V)	

## Absolute Maximum Ratings

Parameters	Values	Units	Conditions
$I_{F(AV)}$ Max. Average Forward (Per Leg) Current * See Fig. 5 (Per Device)	5	A	50% duty cycle @ $T_C = 155^\circ\text{C}$ , rectangular wave form
	10		
$I_{FSM}$ Max. Peak One Cycle Non-Repetitive Surge Current (Per Leg) * See Fig. 7	620	A	5 $\mu\text{s}$ Sine or 3 $\mu\text{s}$ Rect. pulse
	115		10ms Sine or 6ms Rect. pulse
$E_{AS}$ Non-Repetitive Avalanche Energy (Per Leg)	6.75	mJ	$T_J = 25^\circ\text{C}$ , $I_{AS} = 0.30$ Amps, $L = 150$ mH
$I_{AR}$ Repetitive Avalanche Current (Per Leg)	0.30	A	Current decaying linearly to zero in 1 $\mu\text{sec}$ Frequency limited by $T_J$ max. $V_A = 1.5 \times V_R$ typical

## Electrical Specifications

Parameters	Values	Units	Conditions
$V_{FM}$ Max. Forward Voltage Drop (Per Leg) * See Fig. 1 (1)	0.93	V	@ 5A
	1.10	V	@ 10A
	0.73	V	@ 5A
	0.86	V	@ 10A
$I_{RM}$ Max. Reverse Leakage Current (Per Leg) * See Fig. 2 (1)	0.05	mA	$T_J = 25^\circ\text{C}$
	7	mA	$T_J = 125^\circ\text{C}$
$V_{F(TO)}$ Threshold Voltage	0.468	V	$T_J = T_J$ max.
$r_t$ Forward Slope Resistance	28	m $\Omega$	
$C_T$ Max. Junction Capacitance (Per Leg)	200	pF	$V_R = 5V_{DC}$ (test signal range 100Khz to 1Mhz) $25^\circ\text{C}$
$L_S$ Typical Series Inductance (Per Leg)	8.0	nH	Measured lead to lead 5mm from package body
dv/dt Max. Voltage Rate of Change	10000	V/ $\mu\text{s}$	(Rated $V_R$ )

(1) Pulse Width < 300 $\mu\text{s}$ , Duty Cycle < 2%

## Thermal-Mechanical Specifications

Parameters	Values	Units	Conditions
$T_J$ Max. Junction Temperature Range	-55 to 175	$^\circ\text{C}$	
$T_{stg}$ Max. Storage Temperature Range	-55 to 175	$^\circ\text{C}$	
$R_{thJC}$ Max. Thermal Resistance Junction to Case (Per Leg)	3.50	$^\circ\text{C}/\text{W}$	DC operation
$R_{thJC}$ Max. Thermal Resistance Junction to Case (Per Package)	1.75	$^\circ\text{C}/\text{W}$	DC operation
$R_{thCS}$ Typical Thermal Resistance, Case to Heatsink (only for TO-220)	0.50	$^\circ\text{C}/\text{W}$	Mounting surface, smooth and greased
wt Approximate Weight	2 (0.07)	g (oz.)	
T Mounting Torque	Min.	6 (5)	Kg-cm (lbf-in)
	Max.	12 (10)	
Marking Device	10CTQ150S	Case style D <sup>2</sup> Pak	
	10CTQ150-1	Case style TO-262	

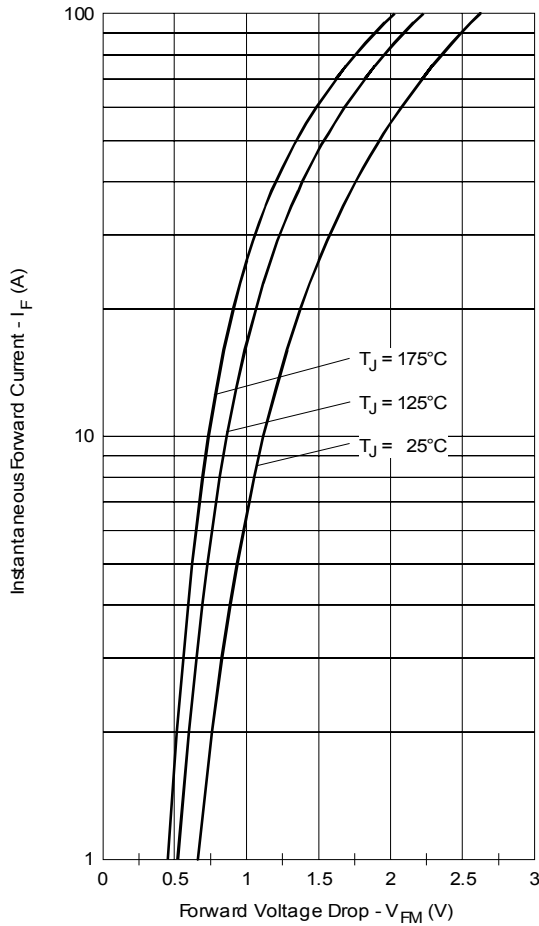

Fig. 1 - Max. Forward Voltage Drop Characteristics (Per Leg)

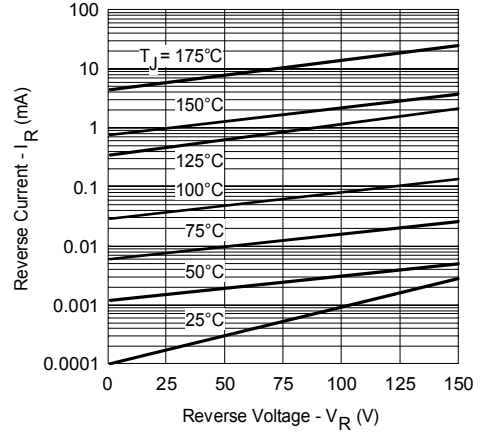

Fig. 2 - Typical Values Of Reverse Current Vs. Reverse Voltage (Per Leg)

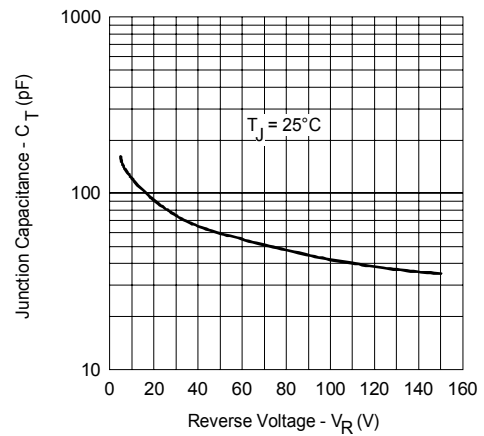

Fig. 3 - Typical Junction Capacitance Vs. Reverse Voltage (Per Leg)

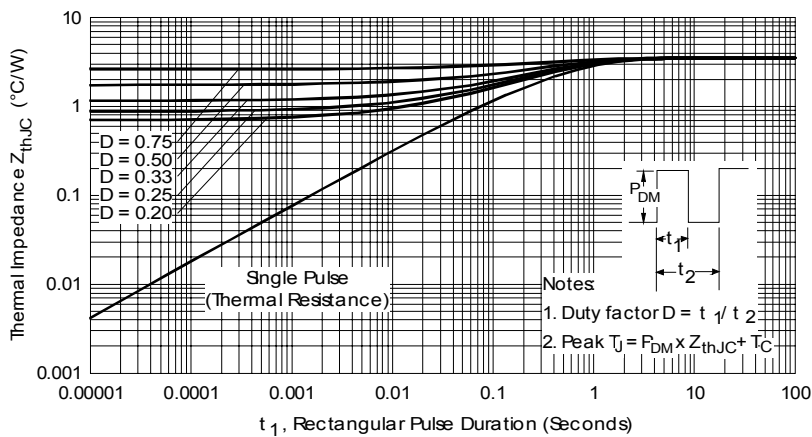

Fig. 4 - Max. Thermal Impedance  $Z_{thJC}$  Characteristics (Per Leg)

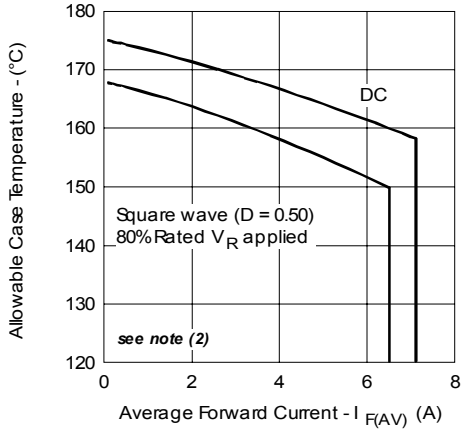

Fig. 5 - Max. Allowable Case Temperature Vs. Average Forward Current (Per Leg)

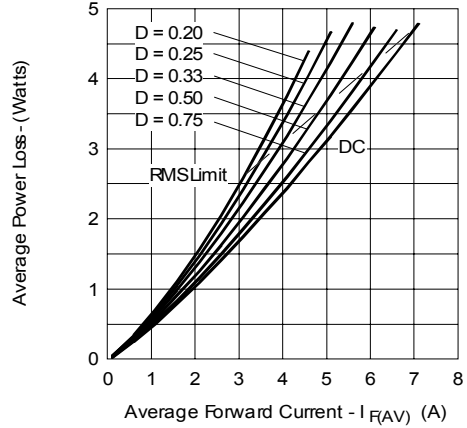

Fig. 6 - Forward Power Loss Characteristics (Per Leg)

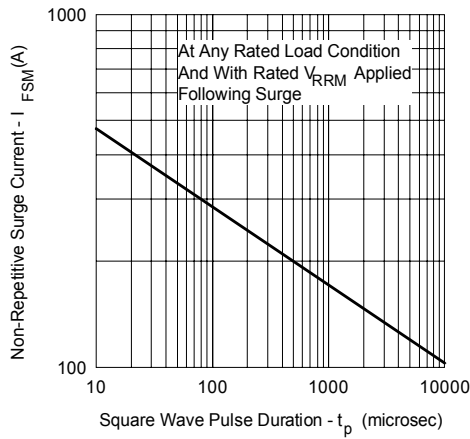

Fig. 7 - Max. Non-Repetitive Surge Current (Per Leg)

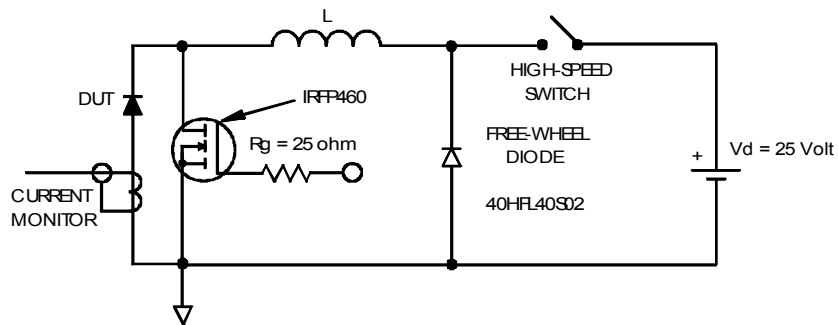

Fig. 8 - Unclamped Inductive Test Circuit

(2) Formula used:  $T_c = T_j - (P_d + P_{d_{REV}}) \times R_{thJC}$ ;

$P_d$  = Forward Power Loss =  $I_{F(AV)} \times V_{FM} @ (I_{F(AV)} / D)$  (see Fig. 6);

$P_{d_{REV}}$  = Inverse Power Loss =  $V_{R1} \times I_R (1 - D)$ ;  $I_R @ V_{R1} = 10V$

Outline Table

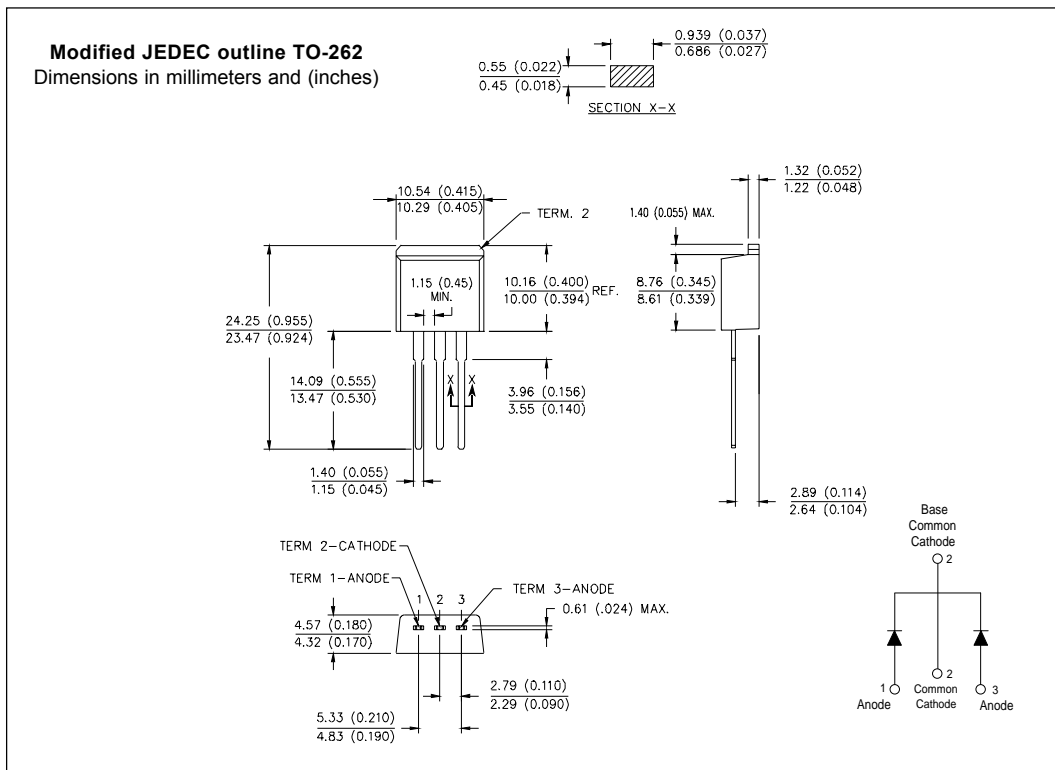
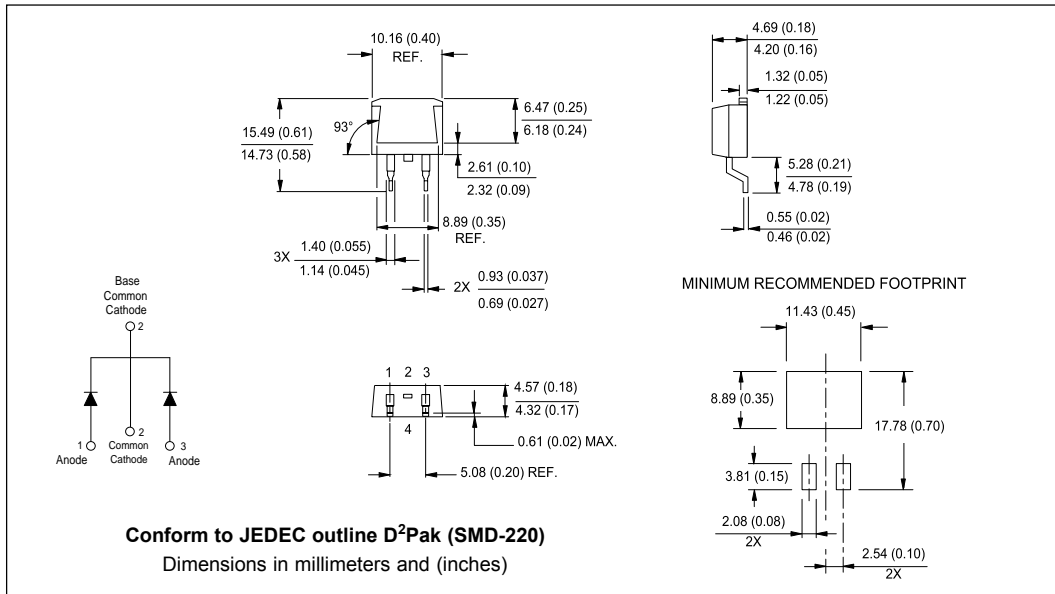

Part Marking Information

**D<sup>2</sup>PAK**

EXAMPLE: THIS IS A 10CTQ150S  
LOT CODE 8024  
ASSEMBLED ON WW 02, 2000

Note: "P" in assembly line position indicates "Lead-Free"

INTERNATIONAL RECTIFIER LOGO  
PART NUMBER  
DATE CODE  
YEAR 0 = 2000  
WEEK 02  
P = LEAD-FREE

**TO-262**

EXAMPLE: THIS IS A 10CTQ150-1  
LOT CODE 1789  
ASSEMBLED ON WW 19, 2002

Note: "P" in assembly line position indicates "Lead-Free"

INTERNATIONAL RECTIFIER LOGO  
PART NUMBER  
DATE CODE  
YEAR 2 = 2002  
WEEK 19  
P = LEAD-FREE

Tape & Reel Information

**TRR**  
FEED DIRECTION

**TRL**  
FEED DIRECTION

Dimensions in millimeters and (inches):

- Carrier width: 13.50 (0.532) DIA., 12.80 (0.504) DIA.
- Carrier length: 26.40 (1.039), 24.40 (0.961)
- Carrier thickness: 60 (2.362) DIA. MIN.
- Carrier hole diameter: 1.60 (0.063) DIA., 1.50 (0.059) DIA.
- Carrier hole spacing: 4.10 (0.161), 3.90 (0.153), 1.60 (0.063) DIA., 1.50 (0.059) DIA.
- Carrier hole offset: 1.85 (0.073), 1.65 (0.065)
- Carrier hole diameter: 11.60 (0.457), 11.40 (0.449)
- Carrier hole offset: 1.75 (0.069) DIA., 1.25 (0.049)
- Carrier hole diameter: 10.90 (0.429), 10.70 (0.421)
- Carrier hole spacing: 16.10 (0.634), 15.90 (0.626)
- Carrier hole diameter: 0.368 (0.0145), 0.342 (0.0135)
- Carrier hole spacing: 15.42 (0.609), 15.22 (0.601)
- Carrier hole diameter: 24.30 (0.957), 23.90 (0.941)
- Carrier hole offset: 4.72 (0.186), 4.52 (0.178)

**SMD-220 Tape & Reel**  
When ordering, indicate the part number, part orientation, and the quantity. Quantities are in multiples of 800 pieces per reel for both TRL and TRR.

Dimensions in millimeters and (inches)

Ordering Information Table

Device Code																	
	<table border="1" style="margin: auto;"> <tr> <td style="padding: 5px;"><b>10</b></td> <td style="padding: 5px;"><b>C</b></td> <td style="padding: 5px;"><b>T</b></td> <td style="padding: 5px;"><b>Q</b></td> <td style="padding: 5px;"><b>150</b></td> <td style="padding: 5px;"><b>S</b></td> <td style="padding: 5px;"><b>TRL</b></td> <td style="padding: 5px;"><b>PbF</b></td> </tr> <tr> <td style="text-align: center;">①</td> <td style="text-align: center;">②</td> <td style="text-align: center;">③</td> <td style="text-align: center;">④</td> <td style="text-align: center;">⑤</td> <td style="text-align: center;">⑥</td> <td style="text-align: center;">⑦</td> <td style="text-align: center;">⑧</td> </tr> </table>	<b>10</b>	<b>C</b>	<b>T</b>	<b>Q</b>	<b>150</b>	<b>S</b>	<b>TRL</b>	<b>PbF</b>	①	②	③	④	⑤	⑥	⑦	⑧
<b>10</b>	<b>C</b>	<b>T</b>	<b>Q</b>	<b>150</b>	<b>S</b>	<b>TRL</b>	<b>PbF</b>										
①	②	③	④	⑤	⑥	⑦	⑧										
<b>1</b>	- Current Rating (10A)																
<b>2</b>	- Circuit Configuration C = Common Cathode																
<b>3</b>	- T = TO-220																
<b>4</b>	- Schottky "Q" Series																
<b>5</b>	- Voltage Rating (150 = 150V)																
<b>6</b>	- <ul style="list-style-type: none"> <li>• S = D<sup>2</sup>Pak</li> <li>• -1= TO-262</li> </ul>																
<b>7</b>	- <ul style="list-style-type: none"> <li>• none = Tube (50 pieces)</li> <li>• TRL = Tape &amp; Reel (Left Oriented - for D<sup>2</sup>Pak only)</li> <li>• TRR = Tape &amp; Reel (Right Oriented - for D<sup>2</sup>Pak only)</li> </ul>																
<b>8</b>	- <ul style="list-style-type: none"> <li>• none = Standard Production</li> <li>• PbF = Lead-Free</li> </ul>																

Data and specifications subject to change without notice.  
 This product has been designed and qualified for Industrial Level and Lead-Free.  
 Qualification Standards can be found on IR's Web site.