

**Features**

- Generation 4 IGBT technology
- Standard: Optimized for minimum saturation voltage and operating frequencies up to 10kHz
- Very low conduction and switching losses
- HEXFRED™ antiparallel diodes with ultra- soft recovery
- Industry standard package
- UL approved

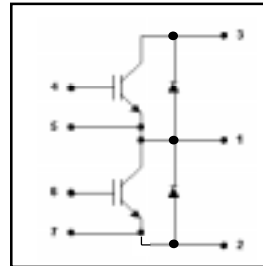

$V_{CES} = 1200V$   
 $V_{CE(on) typ.} = 2.4V$   
@ $V_{GE} = 15V, I_C = 150A$

**Benefits**

- Increased operating efficiency
- Direct mounting to heatsink
- Performance optimized for power conversion: UPS, SMPS, Welding
- Lower EMI, requires less snubbing

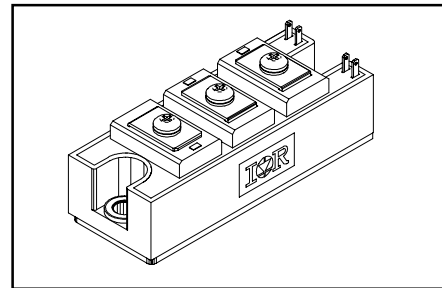

**Absolute Maximum Ratings**

	Parameter	Max.	Units
$V_{CES}$	Collector-to-Emitter Voltage	1200	V
$I_C @ T_C = 25^\circ C$	Continuous Collector Current	150	A
$I_{CM}$	Pulsed Collector Current①	300	
$I_{LM}$	Peak Switching Current②	300	
$I_{FM}$	Peak Diode Forward Current	300	
$V_{GE}$	Gate-to-Emitter Voltage	$\pm 20$	V
$V_{ISOL}$	RMS Isolation Voltage, Any Terminal To Case, t = 1 min	2500	
$P_D @ T_C = 25^\circ C$	Maximum Power Dissipation	780	W
$P_D @ T_C = 85^\circ C$	Maximum Power Dissipation	406	
$T_J$	Operating Junction Temperature Range	-40 to +150	$^\circ C$
$T_{STG}$	Storage Temperature Range	-40 to +125	

**Thermal / Mechanical Characteristics**

	Parameter	Typ.	Max.	Units
$R_{\theta JC}$	Thermal Resistance, Junction-to-Case - IGBT	—	0.16	$^\circ C/W$
$R_{\theta JC}$	Thermal Resistance, Junction-to-Case - Diode	—	0.20	
$R_{\theta CS}$	Thermal Resistance, Case-to-Sink - Module	0.1	—	
	Mounting Torque, Case-to-Heatsink	—	4.0	N·m
	Mounting Torque, Case-to-Terminal 1, 2 & 3③	—	3.0	
	Weight of Module	400	—	g

## Electrical Characteristics @ $T_J = 25^\circ\text{C}$ (unless otherwise specified)

	Parameter	Min.	Typ.	Max.	Units	Conditions
$V_{(BR)CES}$	Collector-to-Emitter Breakdown Voltage	1200	—	—	V	$V_{GE} = 0V, I_C = 1mA$
$V_{CE(on)}$	Collector-to-Emitter Voltage	—	2.4	2.9		$V_{GE} = 15V, I_C = 150A$
		—	2.2	—		$V_{GE} = 15V, I_C = 150A, T_J = 125^\circ\text{C}$
$V_{GE(th)}$	Gate Threshold Voltage	3.0	—	6.0		$I_C = 1.75mA$
$\Delta V_{GE(th)}/\Delta T_J$	Temperature Coeff. of Threshold Voltage	—	-11	—	mV/ $^\circ\text{C}$	$V_{CE} = V_{GE}, I_C = 1.75mA$
$g_{fe}$	Forward Transconductance ④	—	201	—	S	$V_{CE} = 25V, I_C = 150A$
$I_{CES}$	Collector-to-Emitter Leaking Current	—	—	2	mA	$V_{GE} = 0V, V_{CE} = 1200V$
		—	—	20		$V_{GE} = 0V, V_{CE} = 1200V, T_J = 125^\circ\text{C}$
$V_{FM}$	Diode Forward Voltage - Maximum	—	2.7	3.5	V	$I_F = 150A, V_{GE} = 0V$
		—	2.6	—		$I_F = 150A, V_{GE} = 0V, T_J = 125^\circ\text{C}$
$I_{GES}$	Gate-to-Emitter Leakage Current	—	—	500	nA	$V_{GE} = \pm 20V$

## Dynamic Characteristics - $T_J = 125^\circ\text{C}$ (unless otherwise specified)

	Parameter	Min.	Typ.	Max.	Units	Conditions
$Q_g$	Total Gate Charge (turn-on)	—	1139	1709	nC	$V_{CC} = 400V, V_{GE} = 15V$
$Q_{ge}$	Gate - Emitter Charge (turn-on)	—	192	288		$I_C = 171A$
$Q_{gc}$	Gate - Collector Charge (turn-on)	—	377	566		$T_J = 25^\circ\text{C}$
$t_{d(on)}$	Turn-On Delay Time	—	414	—	ns	$R_{G1} = 15\Omega, R_{G2} = 0\Omega$
$t_r$	Rise Time	—	208	—		$I_C = 150A$
$t_{d(off)}$	Turn-Off Delay Time	—	552	—		$V_{CC} = 720V$
$t_f$	Fall Time	—	342	—		$V_{GE} = \pm 15V$
$E_{on}$	Turn-On Switching Energy	—	29	—	mJ	See Fig.17 through Fig.21
$E_{off}$	Turn-Off Switching Energy	—	32	—		
$E_{ts}$	Total Switching Energy	—	61	90		
$C_{ies}$	Input Capacitance	—	25630	—	pF	$V_{GE} = 0V$
$C_{oes}$	Output Capacitance	—	1139	—		$V_{CC} = 30V$
$C_{res}$	Reverse Transfer Capacitance	—	221	—		$f = 1MHz$
$t_{rr}$	Diode Reverse Recovery Time	—	186	—	ns	$I_C = 150A$
$I_{rr}$	Diode Peak Reverse Current	—	133	—		$R_{G1} = 15\Omega$
$Q_{rr}$	Diode Recovery Charge	—	12381	—	nC	$R_{G2} = 0\Omega$
$di_{(rec)}/dt$	Diode Peak Rate of Fall of Recovery During $t_b$	—	2524	—	A/ $\mu\text{s}$	$V_{CC} = 720V$ $di/dt = 1260A/\mu\text{s}$

Details of note ① through ④ are on the last page

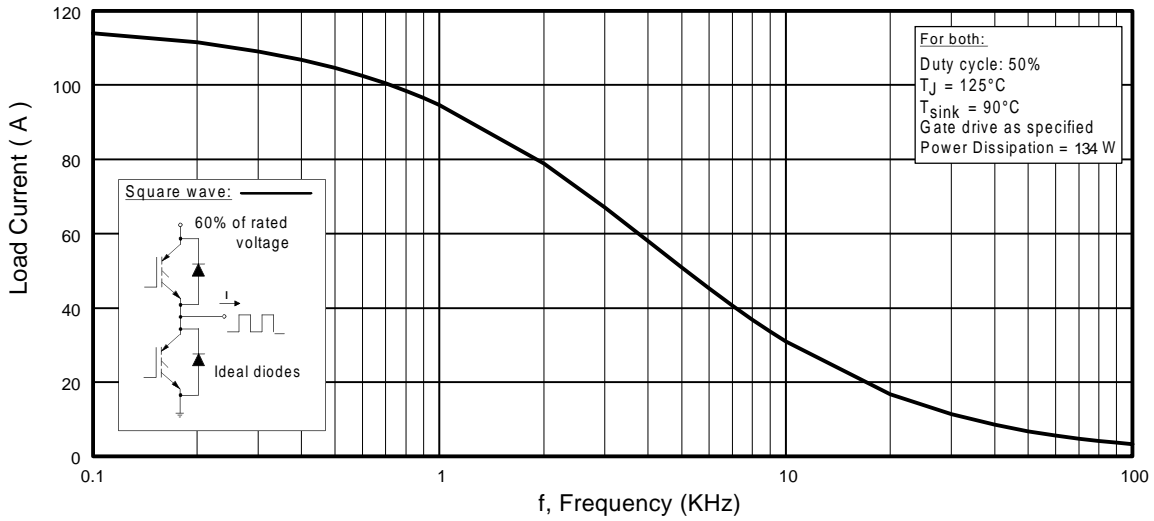

**Fig. 1 - Typical Load Current vs. Frequency**  
 (Load Current =  $I_{\text{RMS}}$  of fundamental)

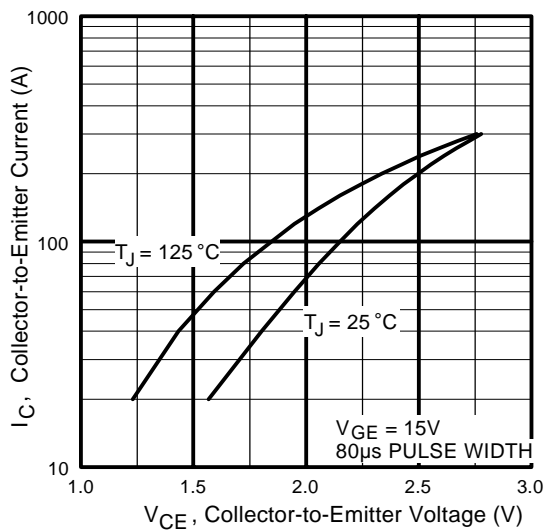

**Fig. 2 - Typical Output Characteristics**

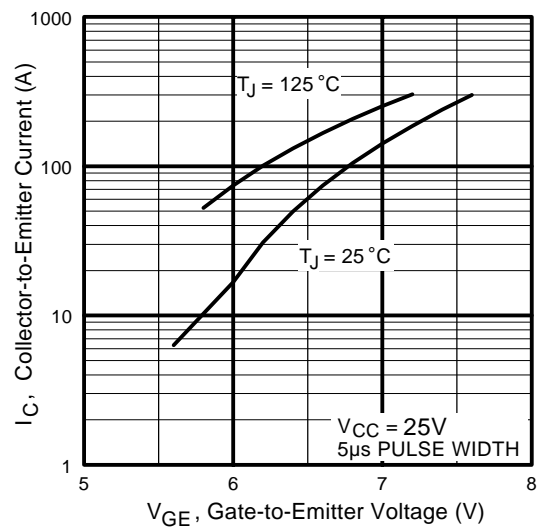

**Fig. 3 - Typical Transfer Characteristics**

# GA150TD120U

International  
**IR** Rectifier

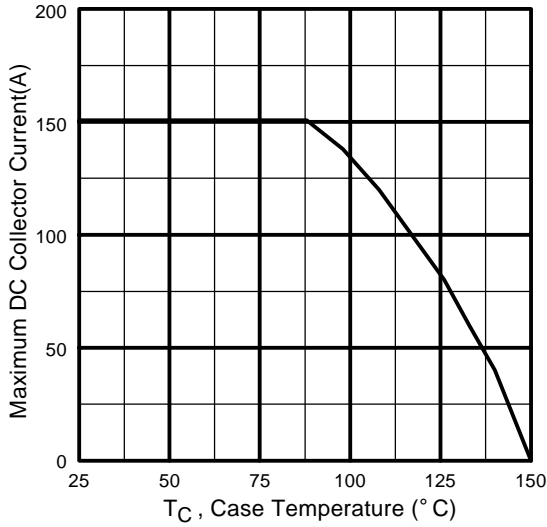

**Fig. 4** - Maximum Collector Current vs. Case Temperature

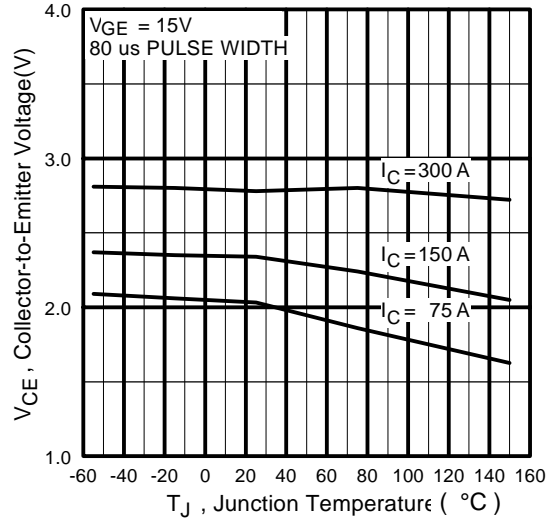

**Fig. 5** - Typical Collector-to-Emitter Voltage vs. Junction Temperature

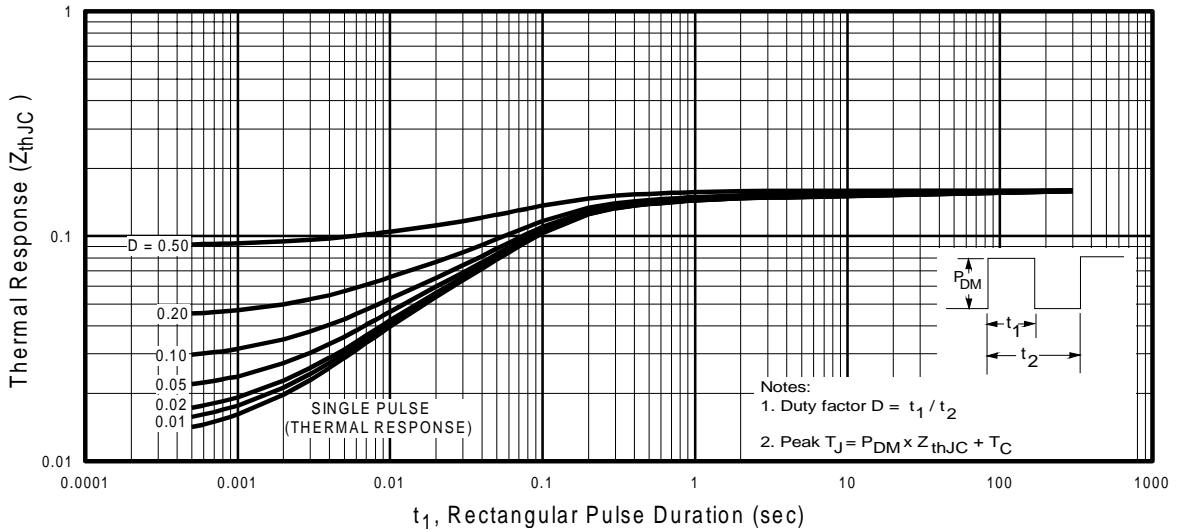

**Fig. 6** - Maximum Effective Transient Thermal Impedance, Junction-to-Case

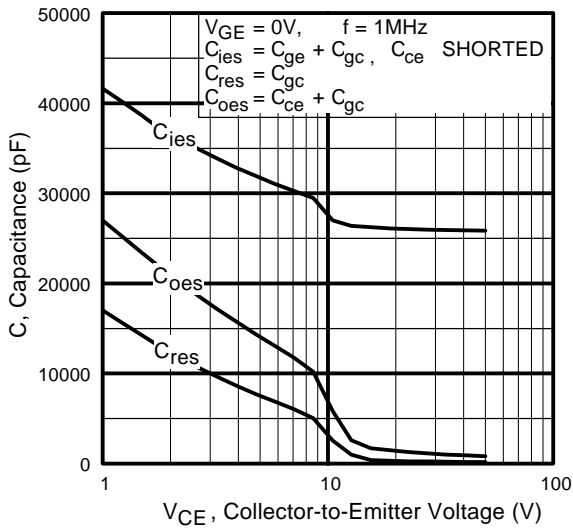

**Fig. 7** - Typical Capacitance vs. Collector-to-Emitter Voltage

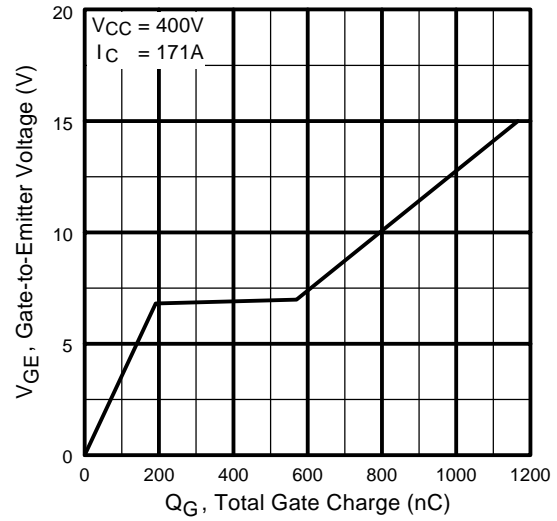

**Fig. 8** - Typical Gate Charge vs. Gate-to-Emitter Voltage

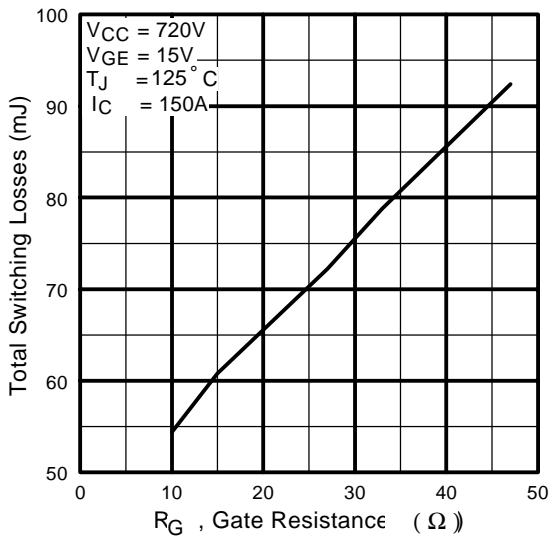

**Fig. 9** - Typical Switching Losses vs. Gate Resistance

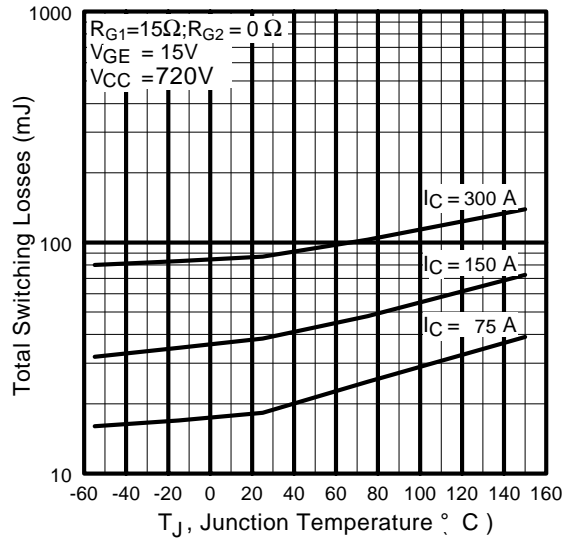

**Fig. 10** - Typical Switching Losses vs. Junction Temperature

# GA150TD120U

International  
**IR** Rectifier

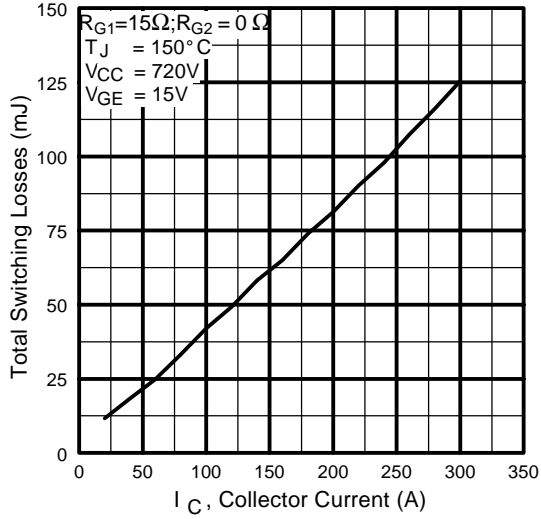

**Fig. 11** - Typical Switching Losses vs. Collector-to-Emitter Current

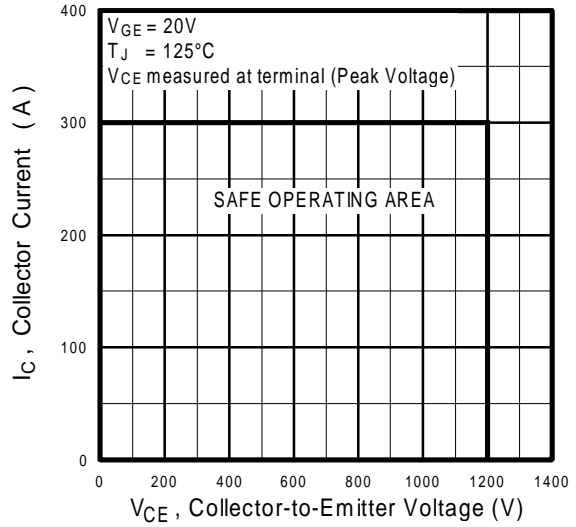

**Fig. 12** - Reverse Bias SOA

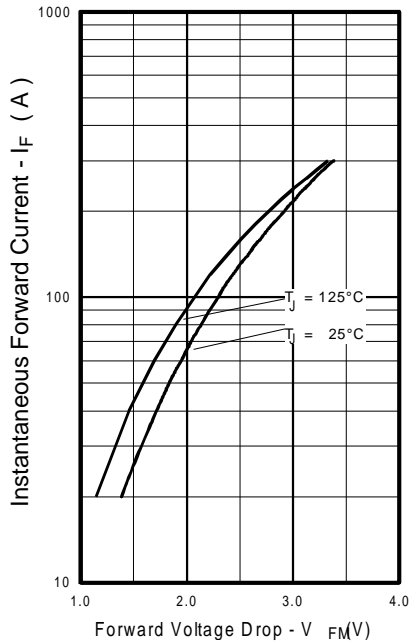

**Fig. 13** - Typical Forward Voltage Drop vs. Instantaneous Forward Current

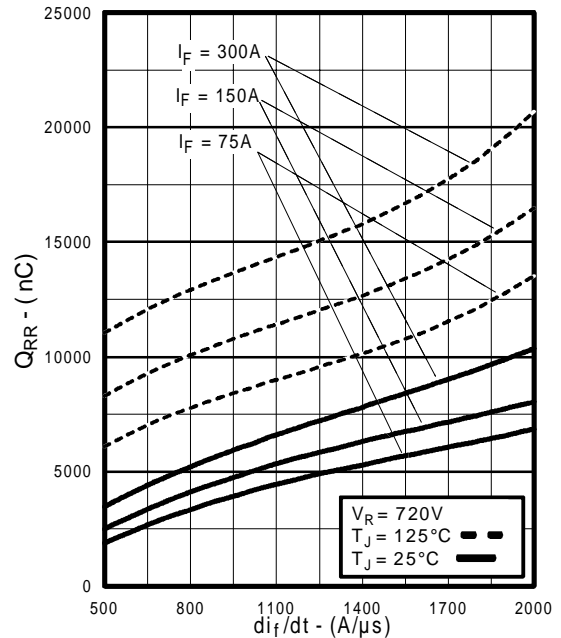

**Fig. 14** - Typical Stored Charge vs.  $di_f/dt$

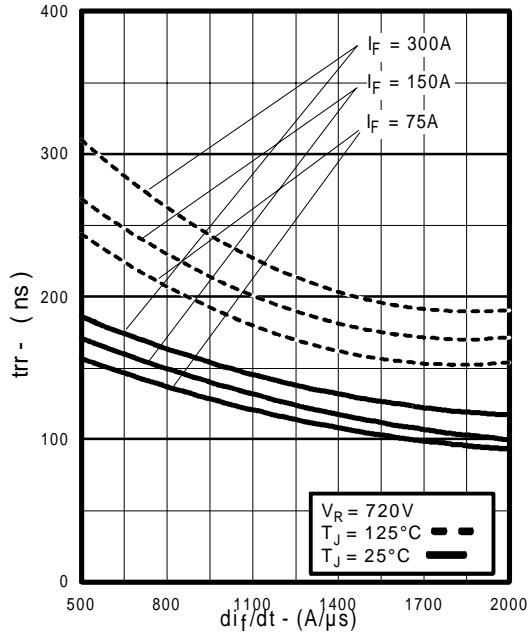

**Fig. 15** - Typical Reverse Recovery vs.  $dI_F/dt$

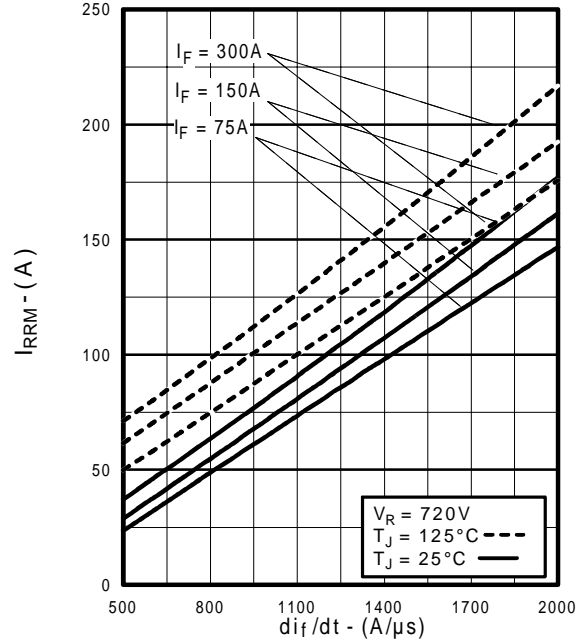

**Fig. 16** - Typical Recovery Current vs.  $dI_F/dt$

# GA150TD120U

International  
**IRF** Rectifier

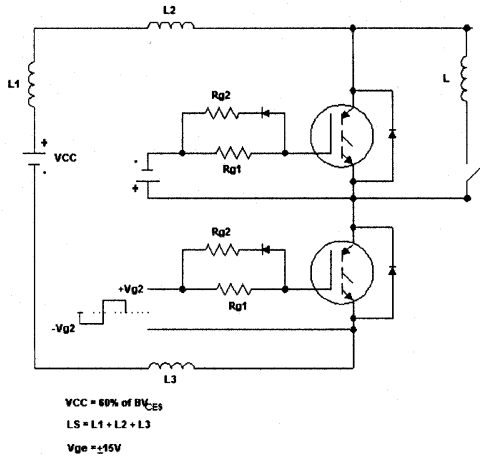

**Fig. 17** - Test Circuit for Measurement of  $I_{LM}$ ,  $E_{on}$ ,  $E_{off}$ (diode),  $t_{rr}$ ,  $Q_{rr}$ ,  $I_{rr}$ ,  $t_{d(on)}$ ,  $t_r$ ,  $t_{d(off)}$ ,  $t_f$

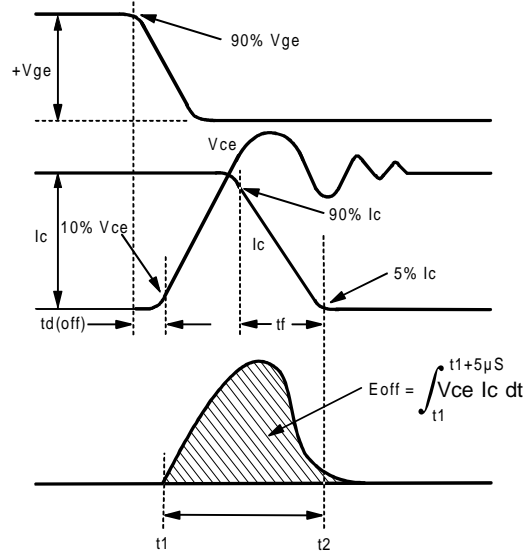

**Fig. 18** - Test Waveforms for Circuit of Fig. 17, Defining  $E_{off}$ ,  $t_{d(off)}$ ,  $t_f$

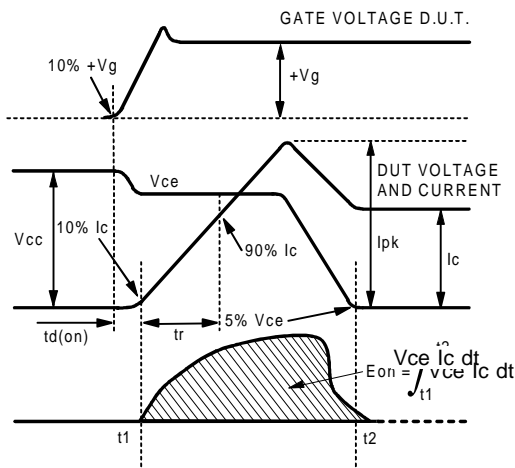

**Fig. 19** - Test Waveforms for Circuit of Fig. 17, Defining  $E_{on}$ ,  $t_{d(on)}$ ,  $t_r$

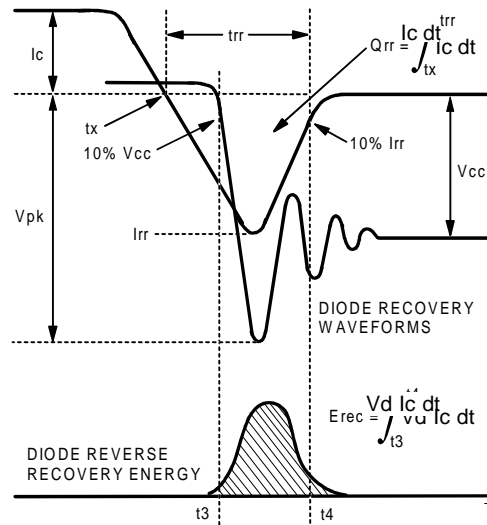

**Fig. 20** - Test Waveforms for Circuit of Fig. 17, Defining  $E_{rec}$ ,  $t_{tr}$ ,  $Q_{rr}$ ,  $I_{rr}$



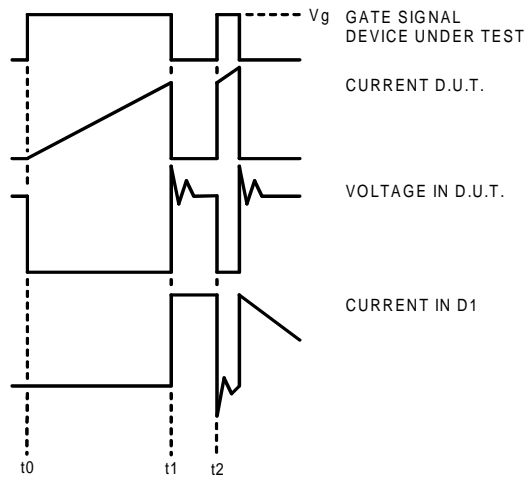

Figure 21. Macro Waveforms for Figure 17's Test Circuit

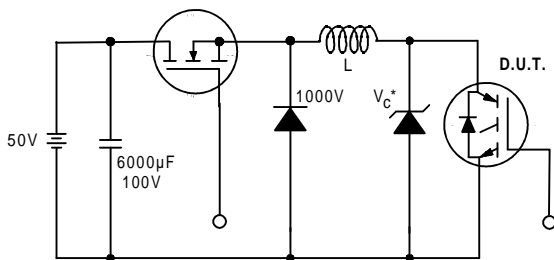

Figure 18. Clamped Inductive Load Test Circuit

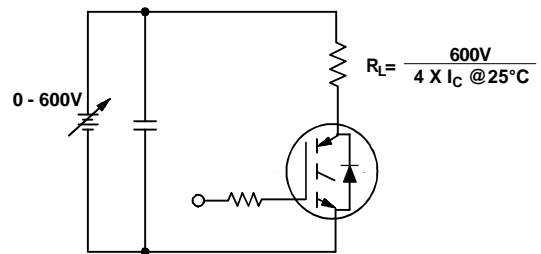

Figure 22. Pulsed Collector Current Test Circuit

# GA150TD120U

International  
**IR** Rectifier

**Notes:**

- ① Repetitive rating;  $V_{GE} = 20V$ , pulse width limited by max. junction temperature.
- ② See fig. 17
- ③ For screws M5x0.8
- ④ Pulse width 80 $\mu$ s; single shot.

## Case Outline — DOUBLE INT-A-PAK

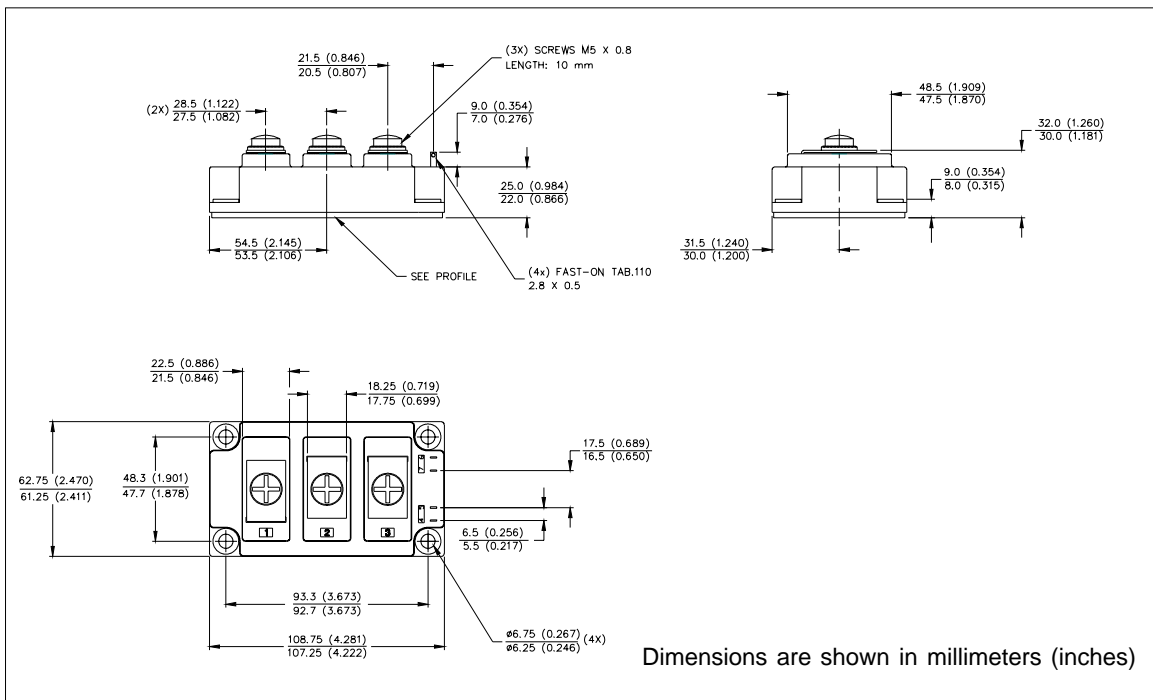

International  
**IR** Rectifier

**WORLD HEADQUARTERS:** 233 Kansas St., El Segundo, California 90245, Tel: (310) 322 3331

**EUROPEAN HEADQUARTERS:** Hurst Green, Oxted, Surrey RH8 9BB, UK Tel: ++ 44 1883 732020

**IR CANADA:** 7321 Victoria Park Ave., Suite 201, Markham, Ontario L3R 2Z8, Tel: (905) 475 1897

**IR GERMANY:** Saalburgstrasse 157, 61350 Bad Homburg Tel: ++ 49 6172 96590

**IR ITALY:** Via Liguria 49, 10071 Borgaro, Torino Tel: ++ 39 11 451 0111

**IR FAR EAST:** K&H Bldg., 2F, 30-4 Nishi-Ikebukuro 3-Chome, Toshima-Ku, Tokyo Japan 171 Tel: 81 3 3983 0086

**IR SOUTHEAST ASIA:** 315 Outram Road, #10-02 Tan Boon Liat Building, Singapore 0316 Tel: 65 221 8371

<http://www.irf.com/> Data and specifications subject to change without notice. 3/98