

International  
**IRF** Rectifier

## IRK.F180.. SERIES

**FAST THYRISTOR/ DIODE and  
 THYRISTOR/ THYRISTOR**

**MAGN-A-pak™ Power Modules**

### Features

- Fast turn-off thyristor
- Fast recovery diode
- High surge capability
- Electrically isolated baseplate
- 3000 V<sub>RMS</sub> isolating voltage
- Industrial standard package
- UL E78996 approved 

180 A

### Description

These series of MAGN-A-pak modules are intended for applications such as self-commutated inverters, DC choppers, electronic welders, induction heating and others where fast switching characteristics are required.

### Major Ratings and Characteristics

Parameters	IRK.F180..	Units
$I_{T(AV)}$	180	A
@ $T_C$	85	°C
$I_{T(RMS)}$	400	A
$I_{TSM}$ @ 50Hz	7130	A
@ 60Hz	7470	A
$I^2t$ @ 50Hz	255	KA <sup>2</sup> s
@ 60Hz	232	KA <sup>2</sup> s
$I^2\sqrt{t}$	2550	KA <sup>2</sup> √s
$t_q$	20 and 25	μs
$t_{rr}$	2	μs
$V_{DRM}/V_{RRM}$	up to 1200	V
$T_J$ range	-40 to 125	°C

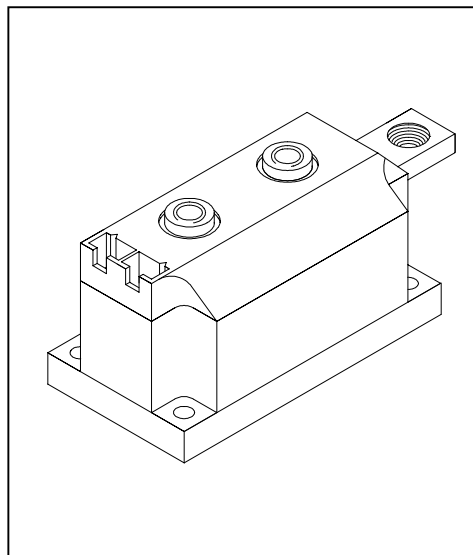

## IRK.F180.. Series

Bulletin I27100 rev. C 03/01

International  
IR Rectifier

### ELECTRICAL SPECIFICATIONS

#### Voltage Ratings

Type number	Voltage Code	$V_{RRM}/V_{DRM}$ maximum repetitive peak reverse voltage V	$V_{RSM}$ , maximum non-repetitive peak rev. voltage V	$I_{RRM}/I_{DRM}$ max. @ $T_J = 125^\circ\text{C}$ mA
IRK.F180-	08	800	800	50
	12	1200	1200	

#### Current Carrying Capacity

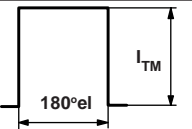
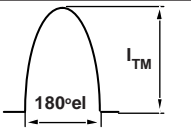
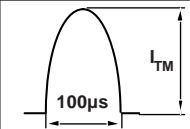
Frequency f				Units			
50Hz	370	530	565	800	2400	3150	A
400Hz	435	650	670	1000	1540	2050	A
2500Hz	290	430	490	720	610	830	A
5000Hz	240	345	390	540	390	540	A
10000Hz	170	270	290	390	-	-	A
Recovery voltage Vr	50	50	50	50	50	50	V
Voltage before turn-on Vd	80% $V_{DRM}$		80% $V_{DRM}$		80% $V_{DRM}$		V
Rise of on-state current di/dt	50	50	-	-	-	-	A/ $\mu\text{s}$
Case temperature	85	60	85	60	85	60	$^\circ\text{C}$
Equivalent values for RC circuit	10 $\Omega$ /0.47 $\mu\text{F}$		10 $\Omega$ /0.47 $\mu\text{F}$		10 $\Omega$ /0.47 $\mu\text{F}$		

#### On-state Conduction

Parameter	IRK.F180..	Units	Conditions
$I_{T(AV)}$ Maximum average on-state current @ Case temperature	180	A	180° conduction, half sine wave
	85	$^\circ\text{C}$	
$I_{T(RMS)}$ Maximum RMS current	400	A	as AC switch
$I_{TSM}$ Maximum peak, one-cycle, non-repetitive surge current	7130	A	t = 10ms No voltage reappplied
	7470		t = 8.3ms
	6000		t = 10ms 100% $V_{RRM}$ reappplied
	6280		t = 8.3ms
$I^2t$ Maximum $I^2t$ for fusing	255	KA <sup>2</sup> s	t = 10ms No voltage reappplied
	232		t = 8.3ms
	180		t = 10ms 100% $V_{RRM}$ reappplied
	164		t = 8.3ms
$I^2\sqrt{t}$ Maximum $I^2\sqrt{t}$ for fusing	2550	KA <sup>2</sup> $\sqrt{\text{s}}$	t = 0 to 10ms, no voltage reappplied
$V_{T(TO)1}$ Low level value of threshold voltage	1.30	V	(16.7% $\times \pi \times I_{T(AV)} < I < \pi \times I_{T(AV)}$ ), $T_J = T_J \text{ max.}$
$V_{T(TO)2}$ High level value of threshold voltage	1.38		( $I > \pi \times I_{T(AV)}$ ), $T_J = T_J \text{ max.}$
$r_{t1}$ Low level value of on-state slope resistance	0.90	mW	(16.7% $\times \pi \times I_{T(AV)} < I < \pi \times I_{T(AV)}$ ), $T_J = T_J \text{ max.}$
$r_{t2}$ High level value of on-state slope resistance	0.71		( $I > \pi \times I_{T(AV)}$ ), $T_J = T_J \text{ max.}$
$V_{TM}$ Maximum on-state voltage drop	1.84	V	$I_{pk} = 600\text{A}$ , $T_J = T_J \text{ max.}$ , $t_p = 10\text{ms}$ sine pulse
$I_H$ Maximum holding current	600	mA	$T_J = 25^\circ\text{C}$ , $I_T > 30\text{A}$
$I_L$ Typical latching current	1000	mA	$T_J = 25^\circ\text{C}$ , $V_A = 12\text{V}$ , $R_a = 6\Omega$ , $I_g = 1\text{A}$

**Switching**

Parameter	IRK.F180..	Units	Conditions
di/dt Maximum non-repetitive rate of rise	800	A/μs	Gate drive 20V, 20Ω, tr ≤ 1ms, V <sub>D</sub> = 80% V <sub>DRM</sub> T <sub>J</sub> = 25°C
t <sub>rr</sub> Maximum recovery time	2	μs	I <sub>TM</sub> = 350A, di/dt = -25A/μs, V <sub>R</sub> = 50V, T <sub>J</sub> = 25°C
t <sub>q</sub> Maximum turn-off time	K 20	J μs	I <sub>TM</sub> = 750A, T <sub>J</sub> = 125°C, di/dt = -25A/μs, V <sub>R</sub> = 50V, dv/dt = 400V/μs linear to 80% V <sub>DRM</sub>

**Blocking**

Parameter	IRK.F180..	Units	Conditions
dv/dt Maximum critical rate of rise of off-state voltage	1000	V/μs	T <sub>J</sub> = 125°C., exponential to = 67% V <sub>DRM</sub>
V <sub>INS</sub> RMS isolation voltage	3000	V	50 Hz, circuit to base, T <sub>J</sub> = 25°C, t = 1 s
I <sub>RRM</sub> Maximum peak reverse and off-state leakage current I <sub>DRM</sub>	50	mA	T <sub>J</sub> = 125°C, rated V <sub>DRM</sub> /V <sub>RRM</sub> applied

**Triggering**

Parameter	IRK.F180..	Units	Conditions
P <sub>GM</sub> Maximum peak gate power	60	W	f = 50 Hz, d% = 50
P <sub>G(AV)</sub> Maximum peak average gate power	10	W	T <sub>J</sub> = 125°C, f = 50Hz, d% = 50
I <sub>GM</sub> Maximum peak positive gate current	10	A	T <sub>J</sub> = 125°C, t <sub>p</sub> ≤ 5ms
-V <sub>GM</sub> Maximum peak negative gate voltage	5	V	
I <sub>GT</sub> Max. DC gate current required to trigger	200	mA	T <sub>J</sub> = 25°C, V <sub>ak</sub> 12V, Ra = 6
V <sub>GT</sub> DC gate voltage required to trigger	3	V	
I <sub>GD</sub> DC gate current not to trigger	20	mA	T <sub>J</sub> = 125°C, rated V <sub>DRM</sub> applied
V <sub>GD</sub> DC gate voltage not to trigger	0.25	V	

**Thermal and Mechanical Specifications**

Parameter	IRK.F180..	Units	Conditions
T <sub>J</sub> Max. junction operating temperature range	- 40 to 125	°C	
T <sub>stg</sub> Max. storage temperature range	- 40 to 150		
R <sub>thJC</sub> Max. thermal resistance, junction to case	0.125	K/W	Per junction, DC operation
R <sub>thC-hs</sub> Max. thermal resistance, case to heatsink	0.02	K/W	Mounting surface flat and greased Per module
T Mounting torque ± 10% MAP to heatsink busbar to MAP	4 - 6 (35 - 53)	Nm (lb*in)	A mounting compound is recommended. The torque should be rechecked after a period of 3 hours to allow for the spread of the compound. Use of cable lugs is not recommended, busbars should be used and restrained during tightening. Threads must be lubricated with a compound
	4 - 6 (35 - 53)		
wt Approximate weight	500 (17.8)	g (oz)	

## IRK.F180.. Series

Bulletin I27100 rev. C 03/01

International  
**IR** Rectifier

### $\Delta R_{thJC}$ Conduction

(The following table shows the increment of thermal resistance  $R_{thJC}$  when devices operate at different conduction angles than DC)

Conduction angle	Sinusoidal conduction	Rectangular conduction	Units	Conditions
180°	0.009	0.006	K/	$T_J$ 125°C
120°	0.010	0.011		
90°	0.014	0.015		
60°	0.020	0.020		
30°	0.032	0.033		

### Ordering Information Table

Device Code							
IRK	T	F	180	-	12	H	K
①	②	③	④		⑤	⑥	⑦
<b>1</b>	-	Module type					
<b>2</b>	-	Circuit configuration					
<b>3</b>	-	Fast SCR					
<b>4</b>	-	Current rating $I_{T(AV)}$	10	rounded			
<b>5</b>	-	Voltage code	Code	100	$V_{RRM}$	(See Voltage Ratings Table)	
<b>6</b>	-	dv/dt code	H	$\leq 400V/\mu s$			
<b>7</b>	-	$t_q$ code	K	$\leq 20\mu s$			
			J	$\leq 25\mu s$			

**NOTE: To order the Optional Hardware see Bulletin I27900**

Outline Table

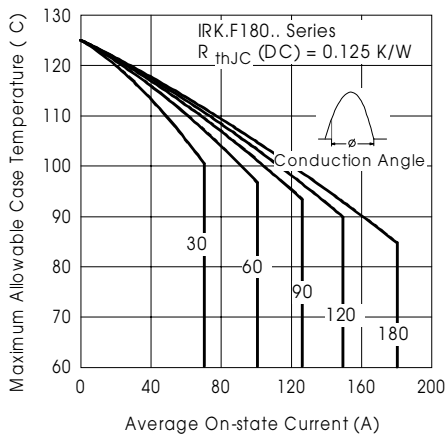
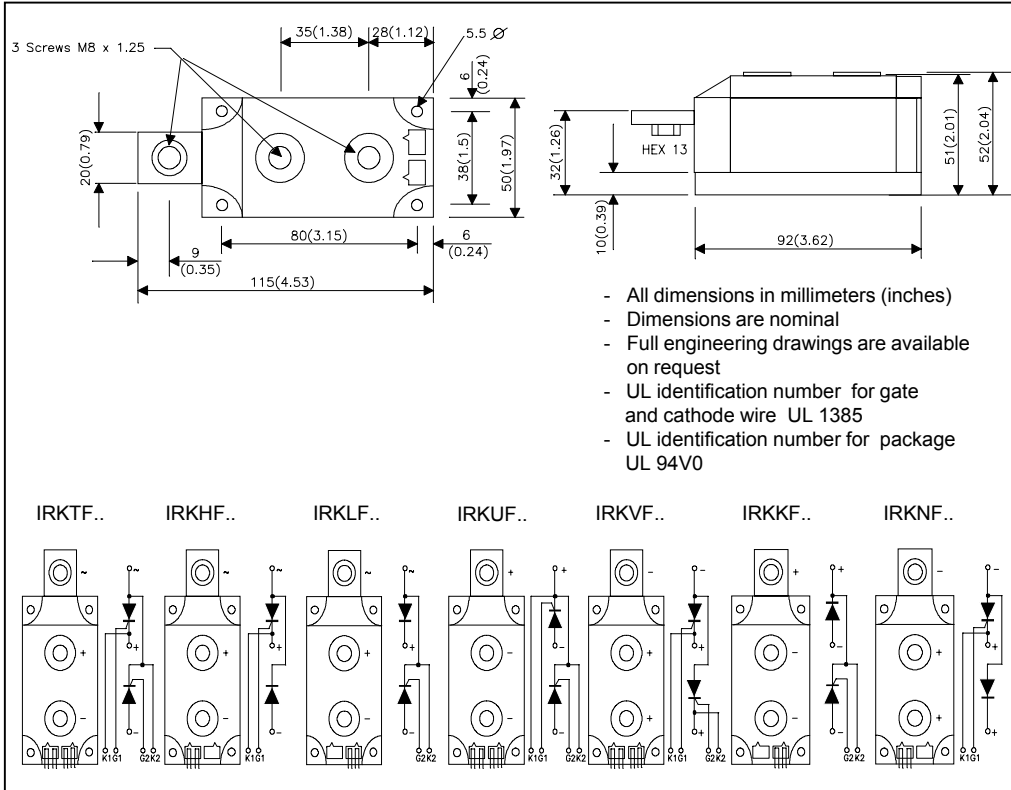

Fig. 1 - Current Ratings Characteristics

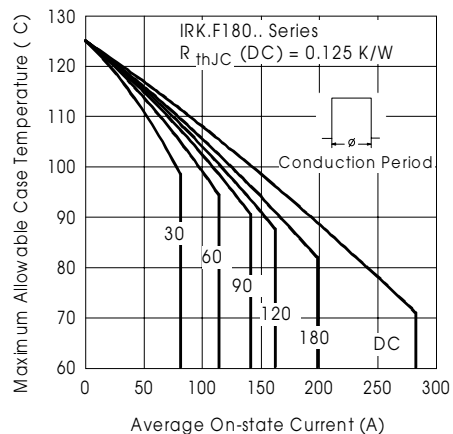

Fig. 2 - Current Ratings Characteristics

**IRK.F180.. Series**

Bulletin I27100 rev. C 03/01

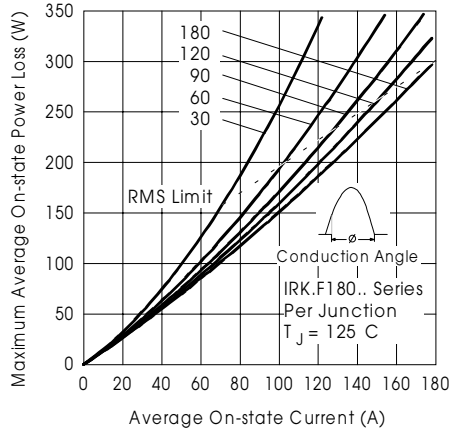

Fig. 3 - n-state Power Loss Characteristics

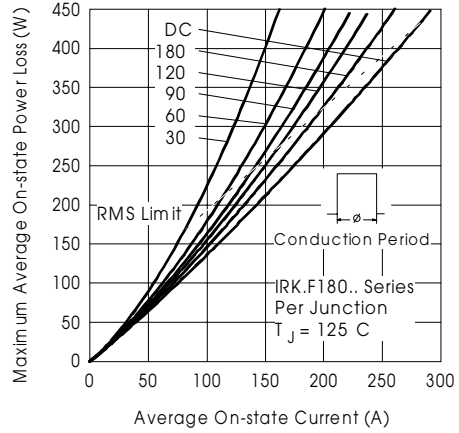

Fig. 4 - n-state Power Loss Characteristics

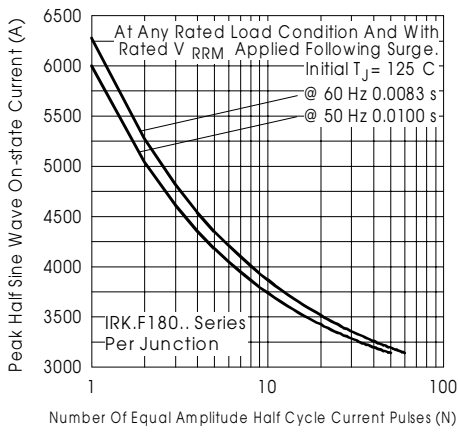

Fig. 5 - Maximum Non-Repetitive Surge Current

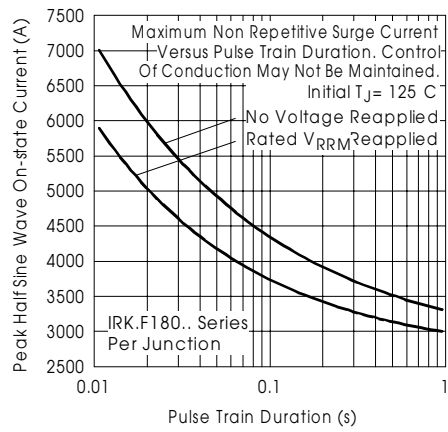

Fig. 6 - Maximum Non-Repetitive Surge Current

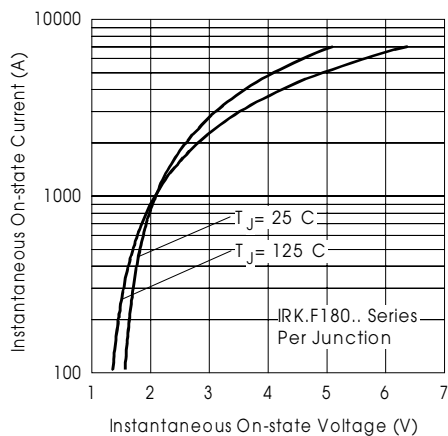

Fig. 7 - n-state Voltage Drop Characteristics

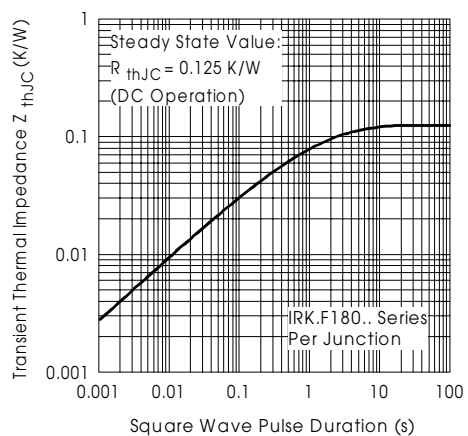

Fig. 8 - Thermal Impedance  $Z_{thJC}$  Characteristics

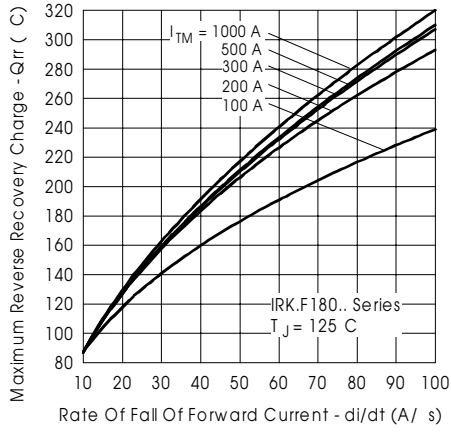

Fig. 9 - Reverse Recovery Charge Characteristics

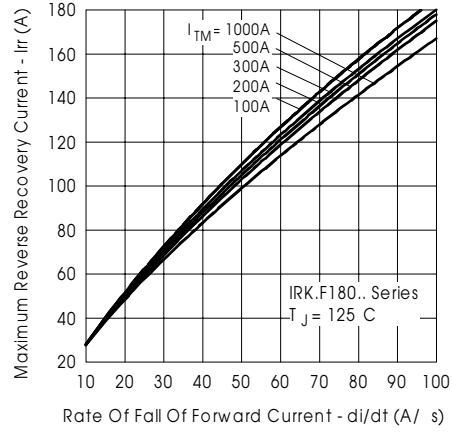

Fig. 10 - Reverse Recovery Current Characteristics

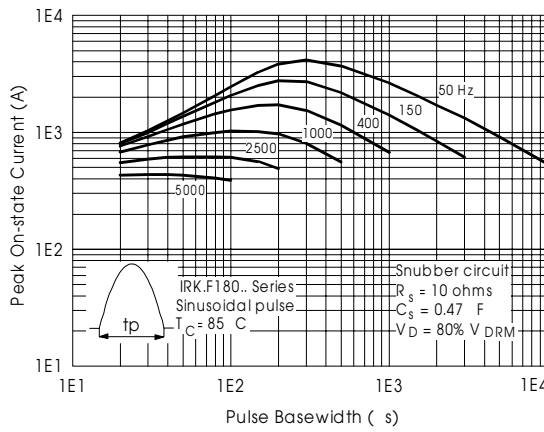

Fig. 11 - Frequency Characteristics

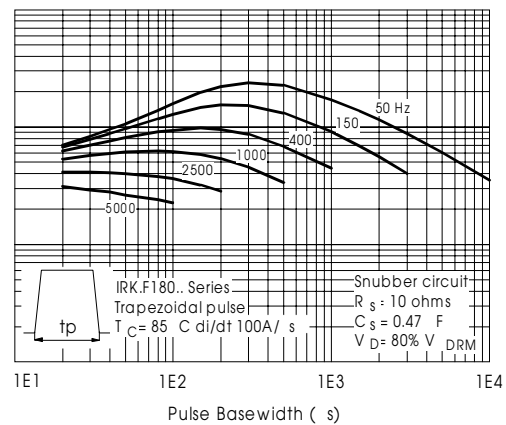
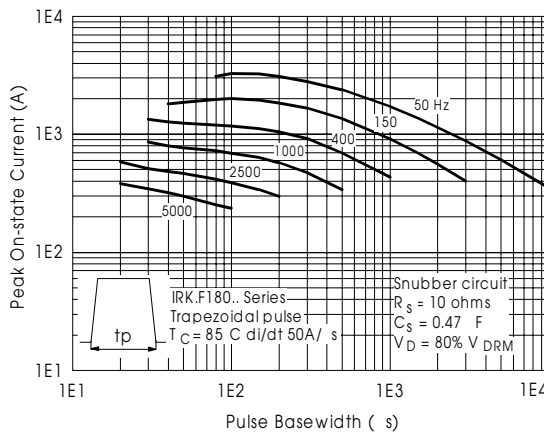
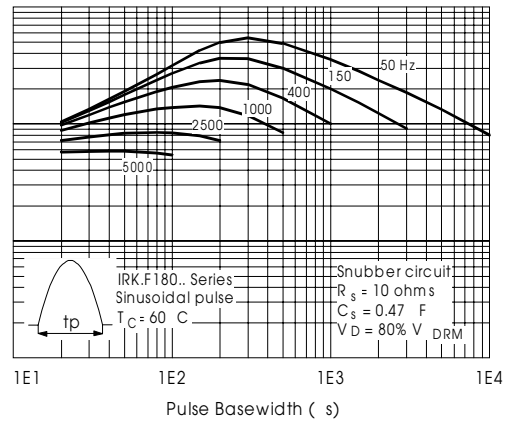

Fig. 12 - Frequency Characteristics

**IRK.F180.. Series**

Bulletin I27100 rev. C 03/01

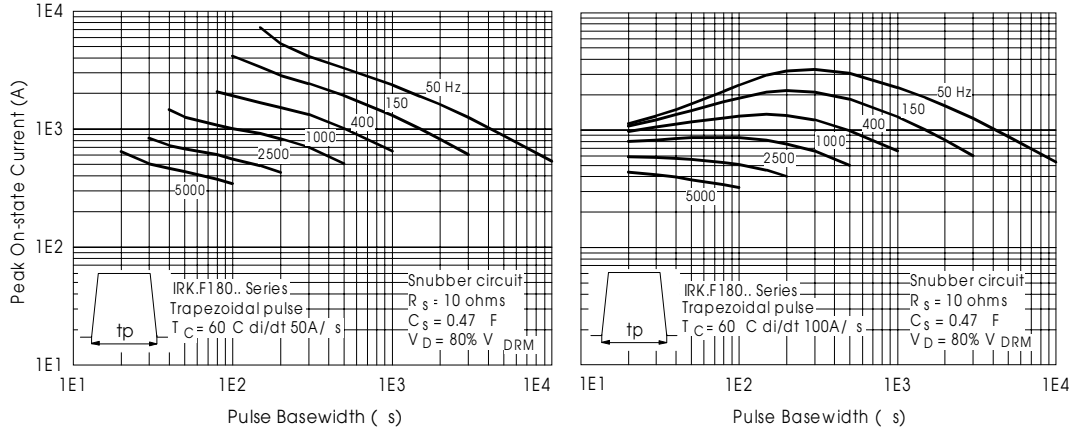

Fig. 13 - Frequency Characteristics

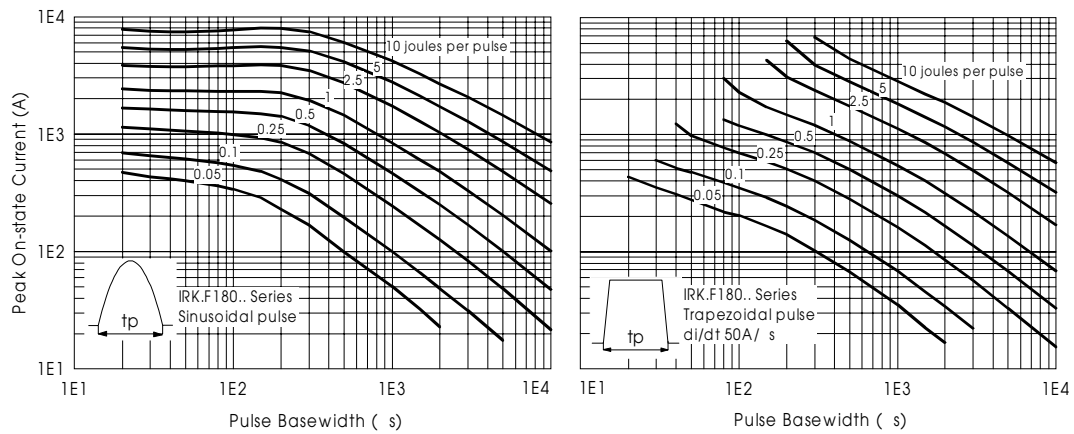

Fig. 14 - Minimum On-state Energy Power Loss Characteristics

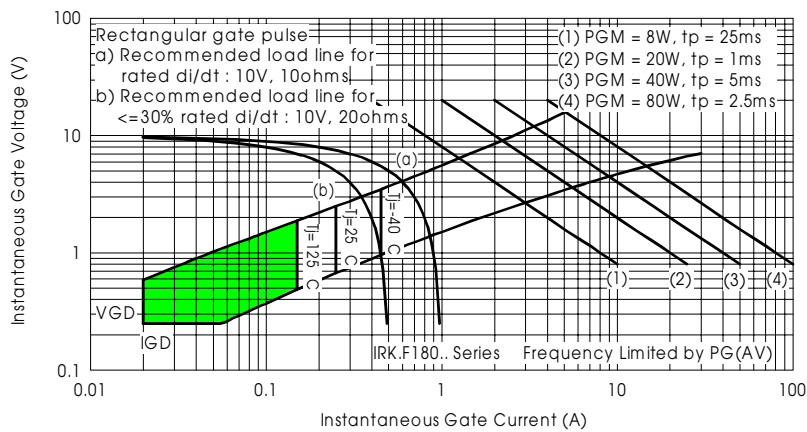

Fig. 15 - Gate Characteristics